

NEW

The heat exchanger for professionals !

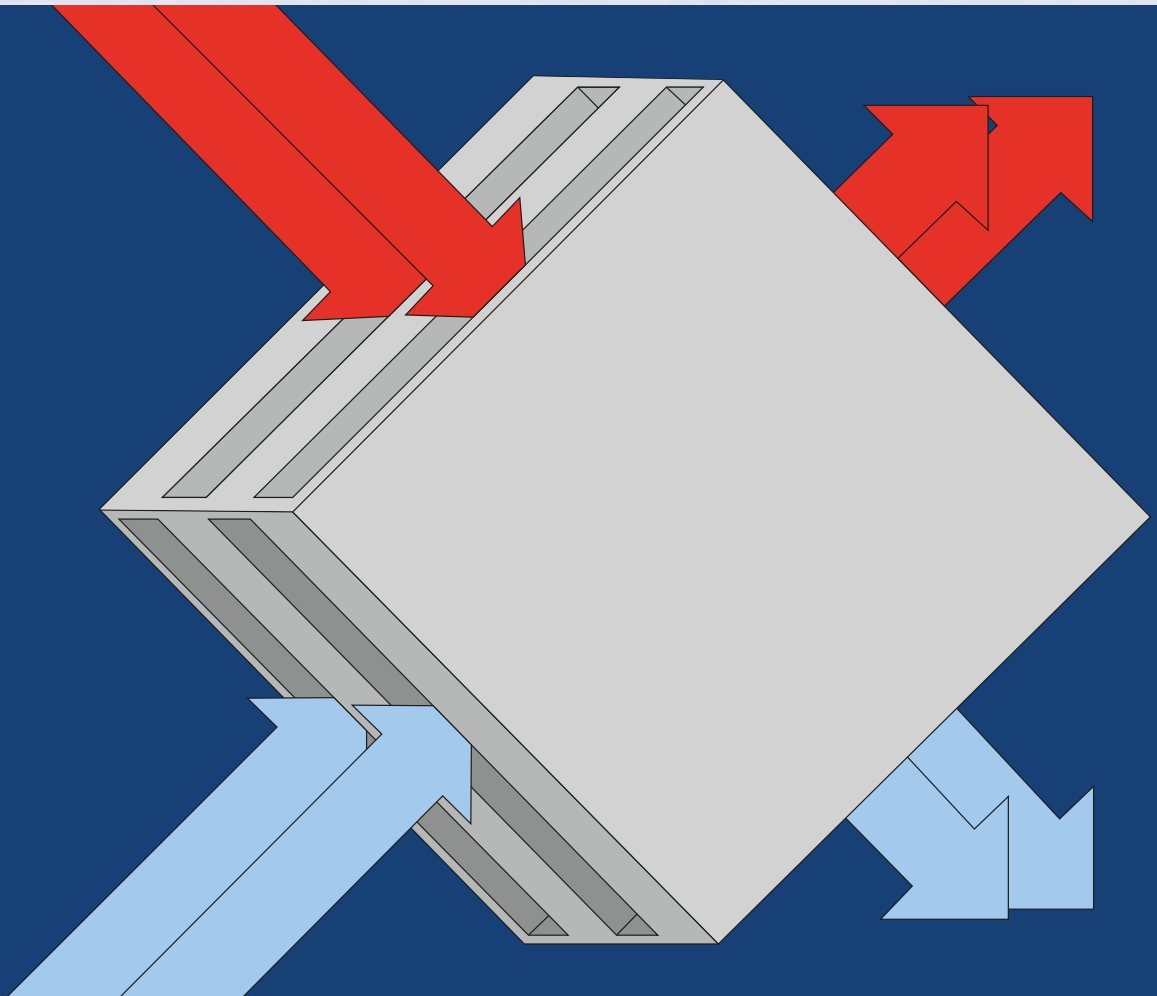

MULTIHEAT X CHANGER
Heat recovery system





MULTIHEAT XCHANGER

**A high efficiency balance ventilation solution with integrated heat recovery
Either stand alone or in combination with Multiheaters !**

Three step heat exchange technology with dry filter cleaning, high efficiency heat-recovery unit and centrifugal fans to create the best result. Cross flow recuperator from easy to clean durable coated aluminum material

With increasing and relatively high energy prices the moment has come to invest in a heat recovery system. Depending on the heat requirement and the outside temperature the pay-back period of such installation will be between 4 and 6 years. Each situation is different, but more and more the poultry farmer is searching for alternatives to reduce costs either with solar panels, windmills or heat recovery.

Optimum climate inside the barn

To realize a healthy climate for poultry the ventilation part is of high importance. But, especially during cold weather circumstances, the heat loss with ventilation is high as well. To complete the heat requirement the heat recovery system is the solution.

Designed by farmers for farmers

- Heat exchanger with 75-85% efficiency with "balance" ventilation
- Saving at least 65% on heating costs
- Cross flow recuperator from easy to clean durable coated aluminium material (ammonia and CO₂ resistant)
- High power centrifugal fan
- Parts and components are of industrial class
- Fully coated, corrosion resistant, durable panels on both in and outside
- High efficiency, low resistance, self cleaning air filters (no water!)
- Optional preheating unit for cold climate conditions to avoid temperature differences
- Stand alone controls or optional remote control
- Dryer climate in the building
- Climate is easier to control

Multiheat X changer, the solution for poultry farms

The Multiheat X changer is made by farmers for farmers, practical and simple.

During its development we took the specific circumstances inside the poultry house into account.

The Multiheat X changer consists of 3 modules : an air inlet and air outlet module by means of centrifugal fans; a heat recovery exchanger module and a filter module.

Warm inside air is taken from the house by a centrifugal fan and passes through the heat exchanger, where cold fresh air simultaneously passes in a cross-flow system without mixing. The warm inside air heats up the cold fresh air, which by a separate centrifugal fan is blown into the house.

This air is clean, fresh with oxygen and preheated to replace the warm air taken from the house. When both amounts of air are equal we speak of "balanced ventilation".

It is not easy to achieve a high efficiency with balanced ventilation, the Multiheat X changer reaches values of 75-85 %.

Heat exchanger

High efficiency 80% cross flow heat recuperator made of durable coated aluminium, ammonia and CO₂ resistant.

Filters

Air from inside the house contains dust and other particles which needs to be cleaned before entering the heat exchanger. Multiheat has high efficiency, low resistance filters, easy accessible and self cleaning ! Compressed air is blown through the filters automatically when needed, thus ensuring clean filters. There is no need to clean with water which would arise problems during cold winters. Once in a cycle the dust is removed from the bottom of the unit.

Bodyworks

Fully coated panels on both in and outside and a special coating on the bottom of the unit protect the material against ammonia and CO₂. All sections in the unit are accessible by means of separate doors. Easy for cleaning or service works.

Option for extra heater

Optional is a preheating system available, which can be built into the unit. Especially in regions with severe winter conditions it preheats the fresh incoming air to keep the returned air temperature at level. Option one: Heating coil with connection to a central (gas or wood) heater. Option two: unique twin coil (no need of a separate heater) energy saving system.

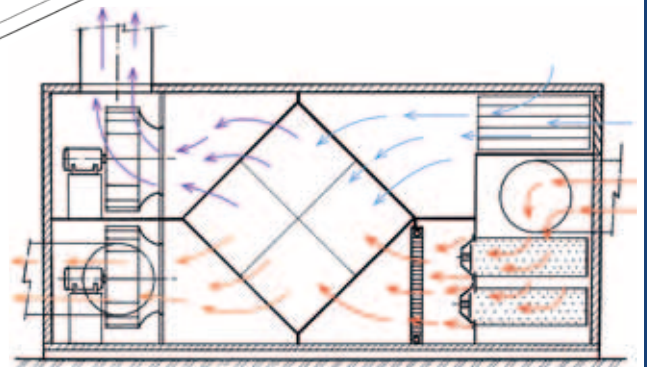
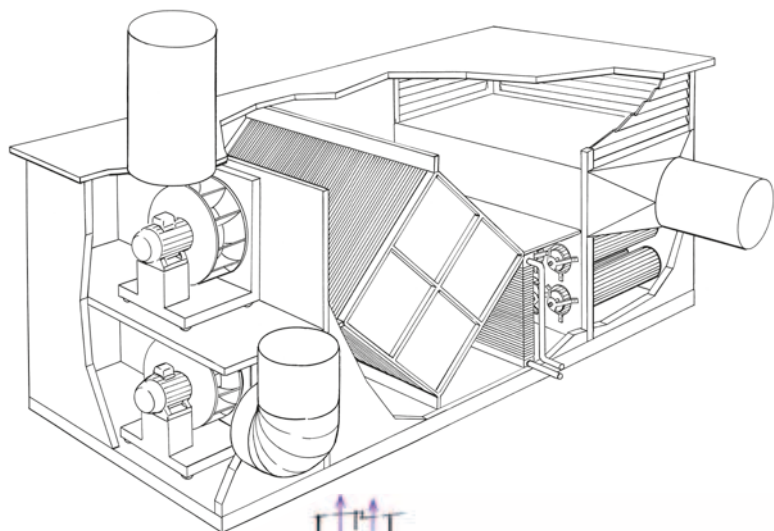
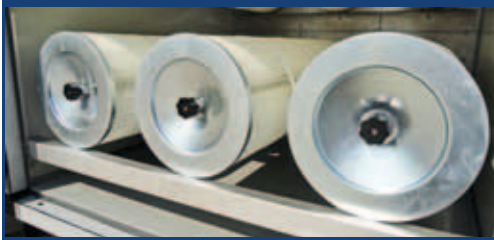
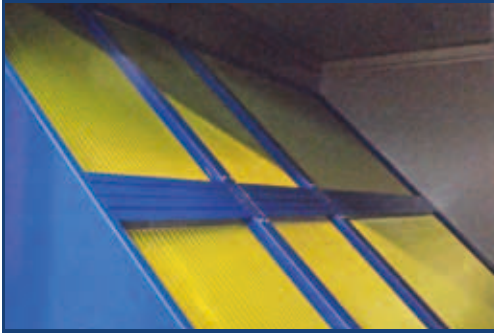

Implementation options

Because of the modular construction principle the Multiheat X changer can fit to any housing situation or connections. Most applied situation is the position in the middle of the length side wall (drawing A). When there is no space available, the unit can also be placed at the end wall (drawing B). In drawing C the unit is connected with 2 houses.

Automatic control

A PLC in the integrated control box regulates all functions automatically based on climatic requirements. Connection to a climate control and/or a central climate computer is always possible.

Placement of the unit

Most units are placed on the floor. The unit has a strong and sturdy steel frame and requires no extra foundation in most cases. If a higher position is required a special frame on legs can be delivered, depending on soil condition and measurements of the unit. The legs do need foundation blocks.

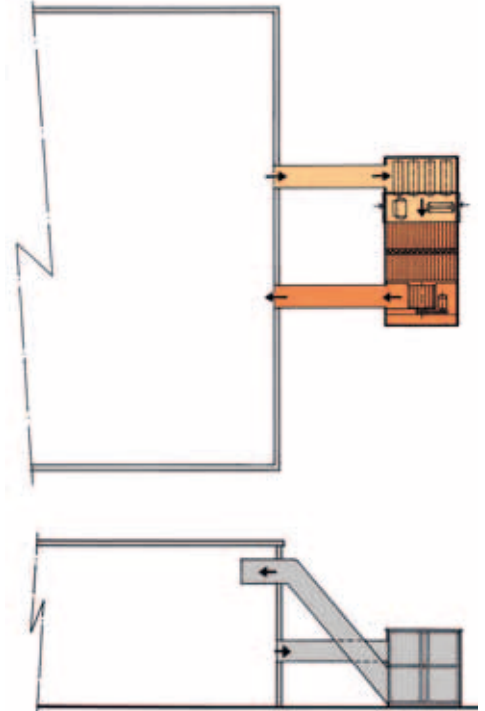
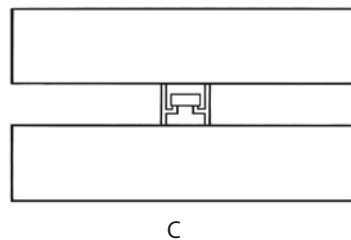
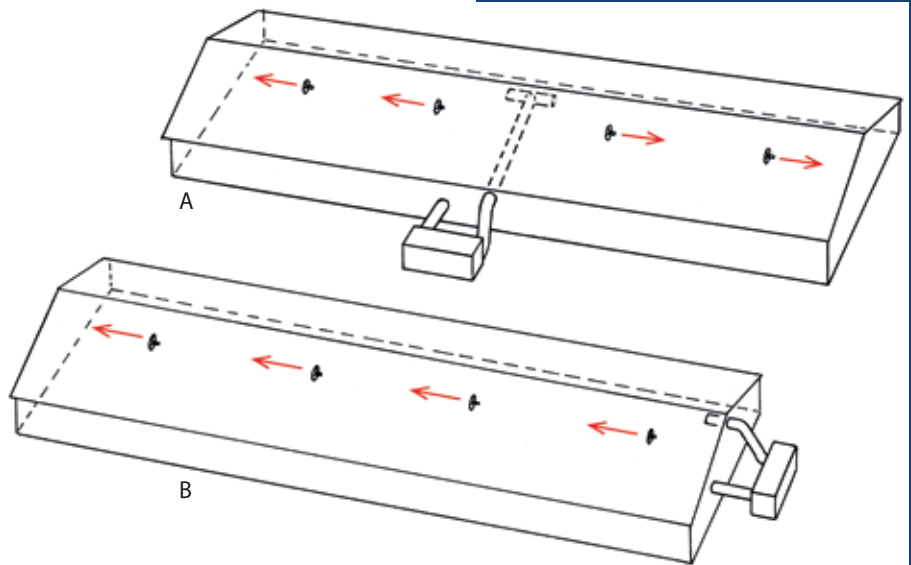

Technical specifications :

Type:	15000	22500
Air volume M3/h:	2000-15000	3000-22500
Air pressure lost in Pa:	206	214
Power in kW :	4.0	5.5
Power supply:	3x400V/660V	3x400V/660V
Sound level db(A):	63	66
Diam. Air exhaust mm:	820	820
Diam. Air supply channel mm:	920	920
Diam. Air intake channel mm:	920	920
Measurements (LxWxH) mm:	5480x1340x2590	5480x2010x2590

Multiheat International B.V.

Factory : Den Akker 10 3862 RB Nijkerk The Netherlands

Office : Transportweg 50 3371 MB Hardinxveld-Giessendam The Netherlands

Phone : 0031 342 712 033 Fax : 0031 842 104 525

Info@multiheat-international.com www.multiheat-international.com